

Features:

- Peel away terminal carrier after soldering.
- Disposable carrier.
- Complete soldering visibility on both sides of PCB.
- Maximum air flow.
- Better flux rinse.
- No contact damage due to terminal carrier insertion.
- No contact pull out due to extraction of terminal carrier.

Specifications:

Terminals:

Brass - Copper Alloy
(C36000) ASTM-B-16

Contacts:

Beryllium Copper - Copper Alloy
(C17200) ASTM-B-194

Solder Preform:

Standard: 63Sn/37Pb
Lead-free: 95.5Sn/4.0Ag/0.5Cu

Plating:

G - Gold over Nickel
M - Matte Tin over Nickel
T - Tin/Lead over Nickel

Gold per ASTM-B-488
Matte Tin per ASTM545-97
Tin/Lead per MIL-P-81728
Nickel per QQ-N-290

Table of Models

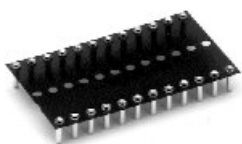

Description: Peel-A-Way® Socket (KS)
Material: Polyimide Film
Index: -269°C to 400°C (-452°F to 752°F)

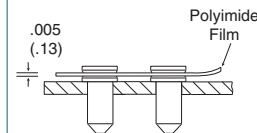

For molded insulators, see pages 28-29.

Options



(shown here on molded socket)

Tape Seal - add 3M to end of part number

- Removable tape seal protects plated contact in harsh environments
- Sealed socket will not allow dirt and other contaminants to enter socket chamber and become entrapped behind contact fingers
- Spray flux without contaminating contact area

Material

Silicone Backed Polyimide Film, -74°C to 260°C (-100°F to 500°F)
Intermittent to 371°C (700°F)

Solder Preform Terminals

See pg. 29 for intrusive reflow application.

Tin/Lead: Type -150 Lead-free: Type -811	Tin/Lead: Type -151 Lead-free: Type -812	Tin/Lead: Type -111 Lead-free: Type -810
<p>Dimensions: .072 Dia. (1.83), .165 (4.19), .125 (3.18), .020 Dia. (.51)</p>	<p>Dimensions: .072 Dia. (1.83), .130 (3.30), .110 (2.79), .020 Dia. (.51)</p>	<p>Peel-A-Way® only</p> <p>Dimensions: .058 Dia. (1.47), .031 (.79), .155 (3.94), .038 Dia. (.97)</p>

How To Order

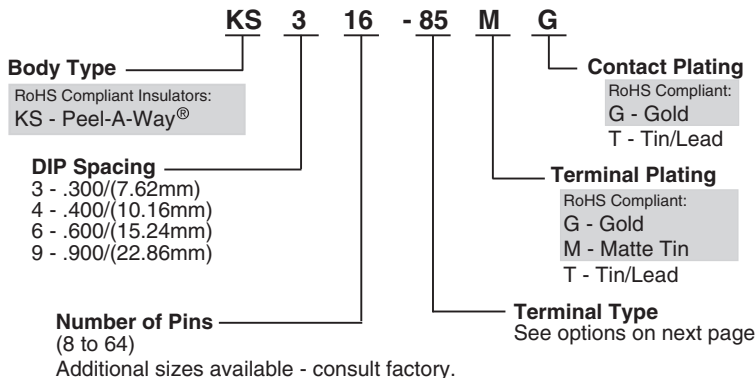

Note: Terminals plated with Matte Tin are available only with Gold plated contacts.



5 Energy Way, West Warwick, RI 02893 USA
Tel: 800.424.9850 | 401.823.5200
Fax: 401.823.8723
info@advanced.com | www.advanced.com
Catalog 16A

Products shown covered by patents issued and/or pending. Specifications subject to change without notice.

inch/(mm)

Additional standard and custom terminals available.
See Terminals section or consult factory.

Standard Terminals

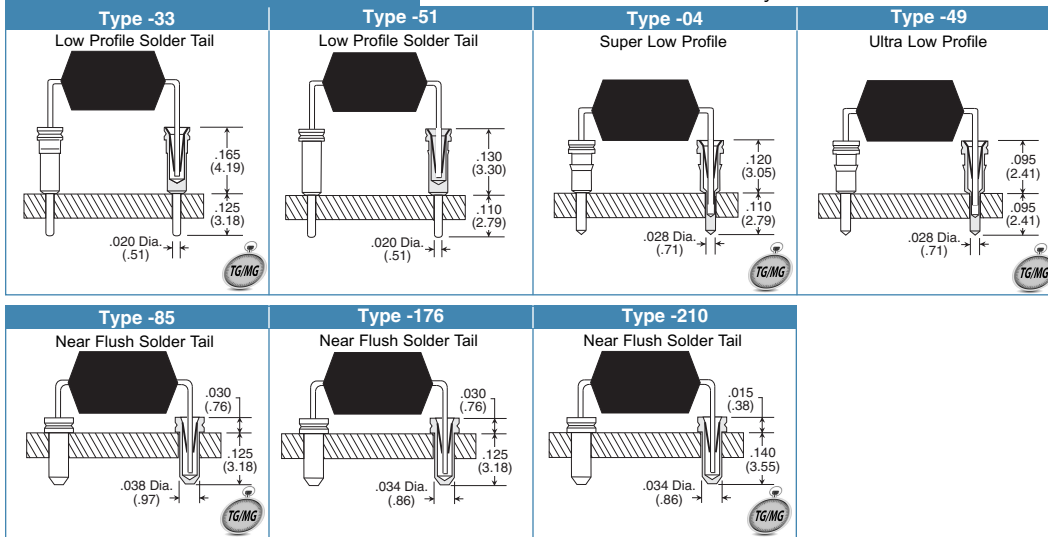

Note: Terminals shown with insulator removed.

Dimensional Information

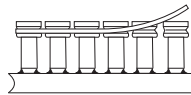
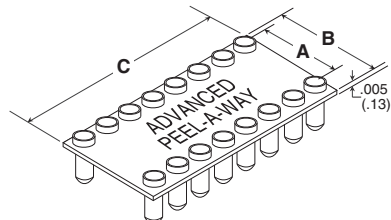

Surface Mount Options Available

# of Pins	A	B	C
8	.300 (7.62)	.400 (10.16)	.400 (10.16)
10	.300 (7.62)	.400 (10.16)	.500 (12.70)
12	.300 (7.62)	.400 (10.16)	.600 (15.24)
14	.300 (7.62)	.400 (10.16)	.700 (17.78)
16	.300 (7.62)	.400 (10.16)	.800 (20.32)
18	.300 (7.62)	.400 (10.16)	.900 (22.86)
20	.300 (7.62)	.400 (10.16)	1.000 (25.40)
22	.300 (7.62)	.400 (10.16)	1.100 (27.94)
24	.300 (7.62)	.400 (10.16)	1.200 (30.48)
28	.300 (7.62)	.400 (10.16)	1.400 (35.56)
40	.300 (7.62)	.400 (10.16)	2.000 (50.80)
16	.400 (10.16)	.500 (12.70)	.800 (20.32)
20	.400 (10.16)	.500 (12.70)	1.000 (25.40)
22	.400 (10.16)	.500 (12.70)	1.100 (27.94)
24	.400 (10.16)	.500 (12.70)	1.200 (30.48)
28	.400 (10.16)	.500 (12.70)	1.400 (35.56)
32	.400 (10.16)	.500 (12.70)	1.600 (40.64)

# of Pins	A	B	C
10	.600 (15.24)	.700 (17.76)	.500 (12.70)
18	.600 (15.24)	.700 (17.76)	.900 (22.86)
20	.600 (15.24)	.700 (17.76)	1.000 (25.40)
22	.600 (15.24)	.700 (17.76)	1.100 (27.94)
24	.600 (15.24)	.700 (17.76)	1.200 (30.48)
28	.600 (15.24)	.700 (17.76)	1.400 (35.56)
32	.600 (15.24)	.700 (17.76)	1.600 (40.64)
36	.600 (15.24)	.700 (17.76)	1.800 (45.72)
40	.600 (15.24)	.700 (17.76)	2.000 (50.80)
42	.600 (15.24)	.700 (17.76)	2.100 (53.34)
48	.600 (15.24)	.700 (17.76)	2.400 (60.96)
64	.600 (15.24)	.700 (17.76)	3.200 (81.28)
32	.900 (22.86)	1.000 (25.40)	1.600 (40.64)
36	.900 (22.86)	1.000 (25.40)	1.800 (45.72)
40	.900 (22.86)	1.000 (25.40)	2.000 (50.80)
52	.900 (22.86)	1.000 (25.40)	2.600 (66.04)
56	.900 (22.86)	1.000 (25.40)	2.800 (71.12)
64	.900 (22.86)	1.000 (25.40)	3.200 (81.28)

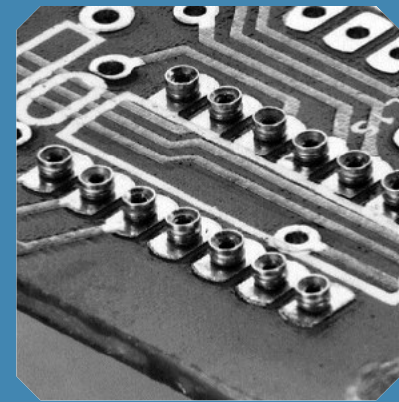

How To Use:

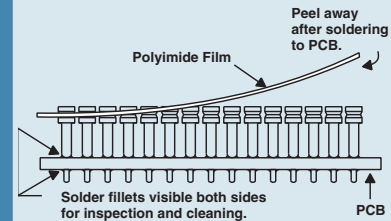

1. Place socket on PC board.
2. Send PC board and socket through soldering operation.
3. Peel away polyimide film carrier for complete solder joint visibility or leave in place for added stability.

Available Online:

- RoHS Qualification Test Report
- CAD Drawings

EXPRESS Delivery



Terminals shown with the new EXPRESS symbol are available in most insulator body types with fast lead time. Some quantity and plating restrictions apply. Search our Distributor inventory online at www.advanced.com, or check with customer service for availability.



5 Energy Way, West Warwick, RI 02893 USA
Tel: 800.424.9850 | 401.823.5200
Fax: 401.823.8723
info@advanced.com | www.advanced.com
Catalog 16A